

REV.	EQ. NO.	LOCATIONS	DESCRIPTION	DATE	OWNER
A				13/4/25	

### Ordering information

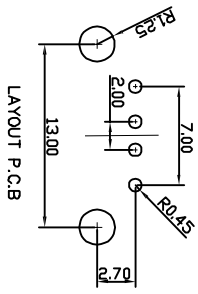
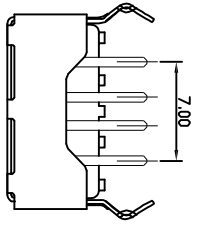
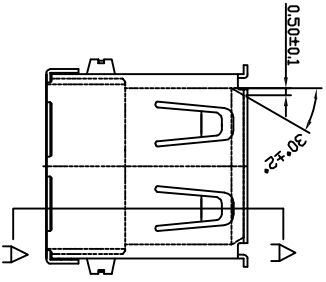
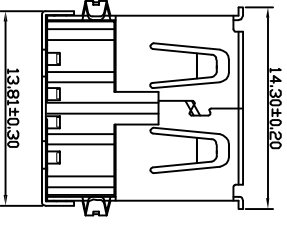
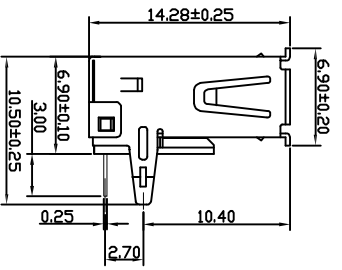
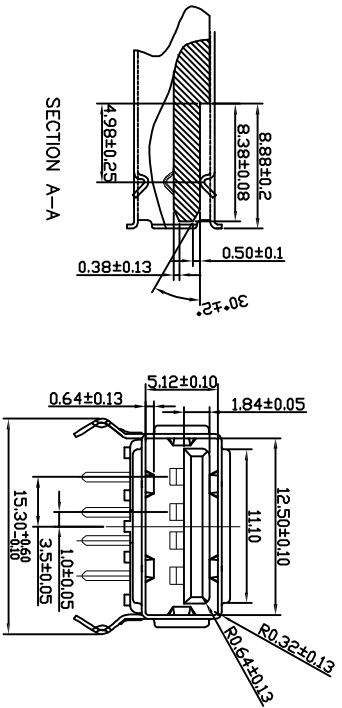
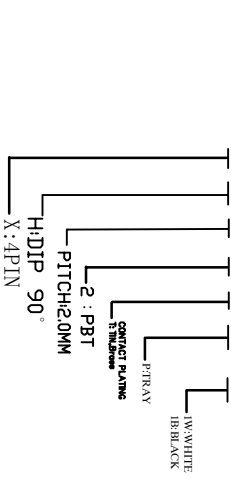

NO.	NAME	MATERIAL	FINISH	REMARK	Q'TY
1	HOUSING	P. B. T	White/Black	-1W/-1B	1
2	PIN TERM	Brass T:0.25	Gold/TIN PLATED	Mold "S800" 100° "N180"	4
3	SHELL	SPCC T:0.3	NICKEL PLATED	Color "100a" "N100" 120°	1

TOLERANCE UNSPECIFIED:

- X ±0.50
- XX ±0.25
- XXX ±0.15
- XXX ±0.05
- X' ±2'
- FT'
- X.X'



UNIT: mm [inch]  
SCALE: 1:1 SIZE: A4

**DISNT** 得升電子股份有限公司  
DISNT MECHANICAL ELECTRONIC CO., LTD

DRAWN BY: 杨熊  
DATE: 11-8-6  
TITLE: 成品规格图  
PART NAME: USB AP DIP 4P 90°

CHECKED BY: 何智权  
DATE: 11-8-6  
PART NO.: T-DUBXHH4XP-XX

APPROVED BY: 陈宗渊  
DATE: 11-8-6  
DRAW NO.: T-DUBXHH2XP-XX  
SHEET: 1 OF 1